

Cleaning water drains

All models

Revision: Model 140 added.

- Upper fill-in well

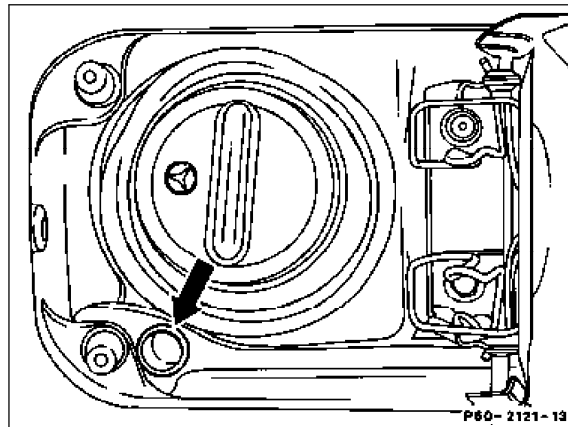

- Lower fill-in well

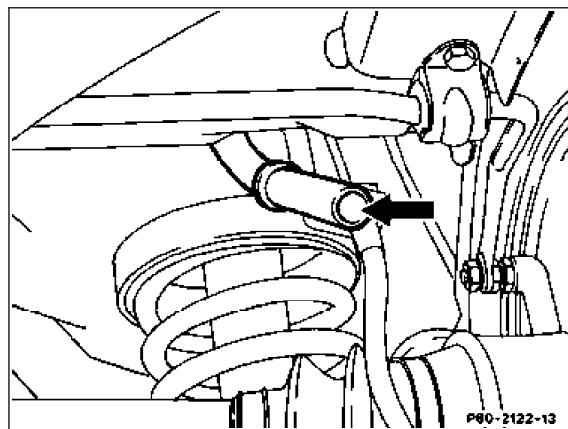

Models 107, 123, 124, 126, 201

- Rear fender

Models 107, 123, 124, 126, 140, 201

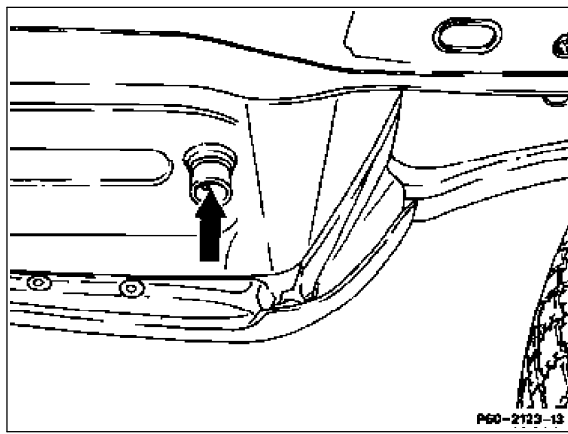

- Rear fender
- Tank filler well, below

Model 129

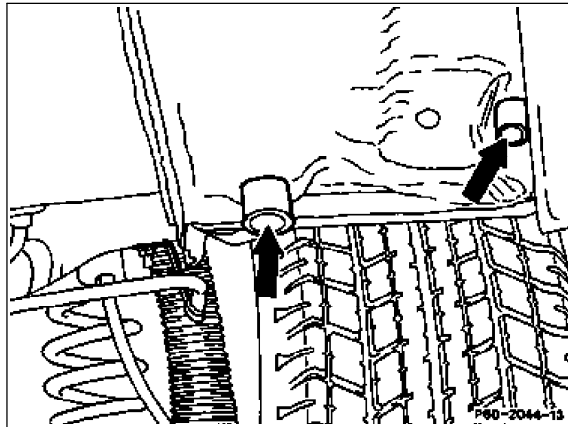

- Spare wheel well

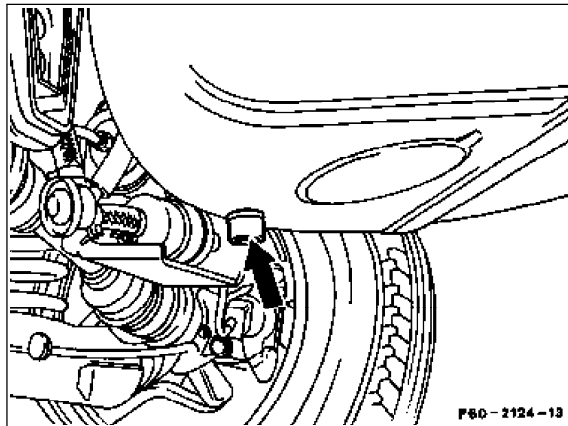

- Side member

Models 123, 124, 126, 129, 140, 201

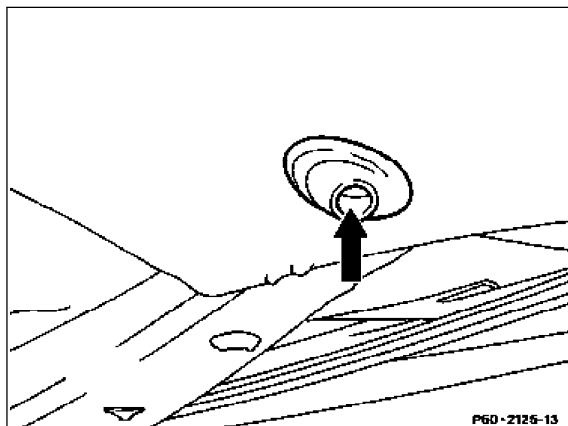

- Side member front

Model 107

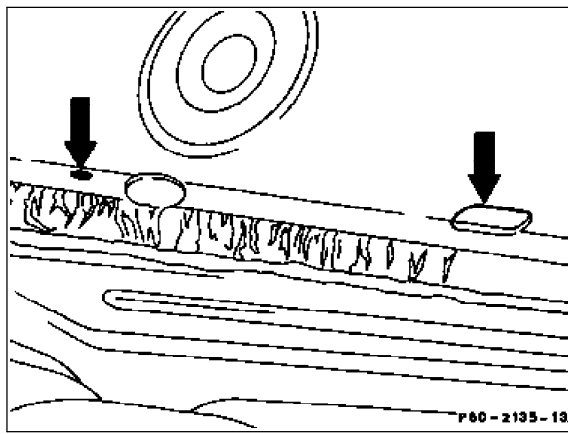

- Side member rear

Model 107

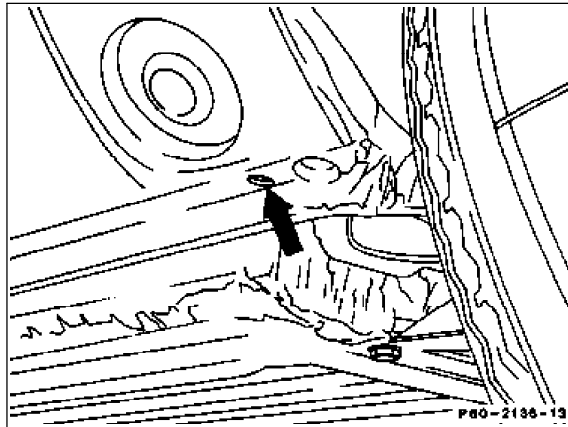

- Side member connecting range front wall pillar

Model 107

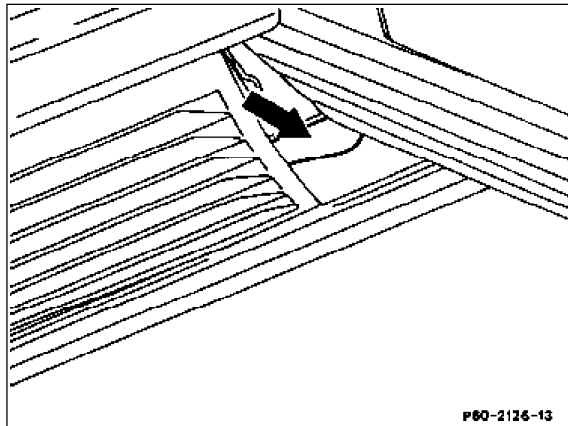

- Engine compartment top

Model 123

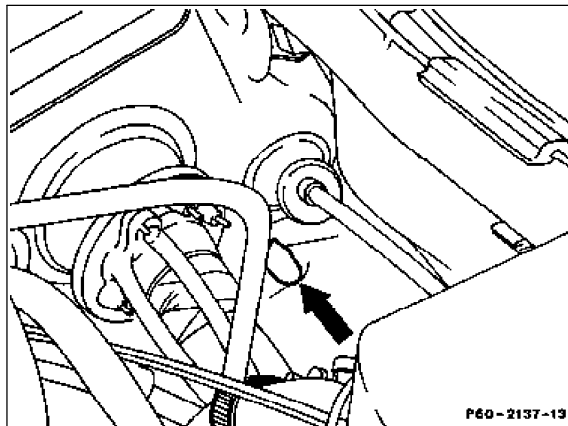

- Engine compartment below

Model 123

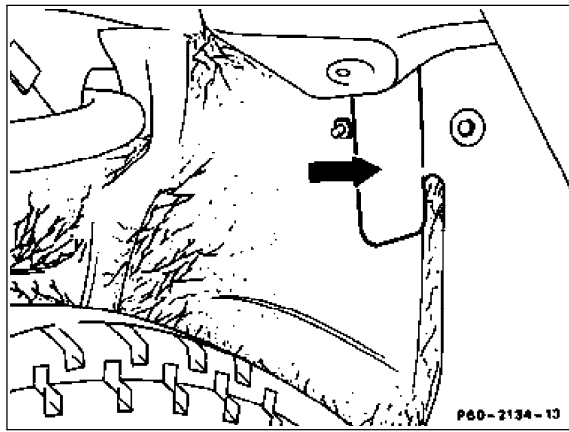

- Water box

Model 123

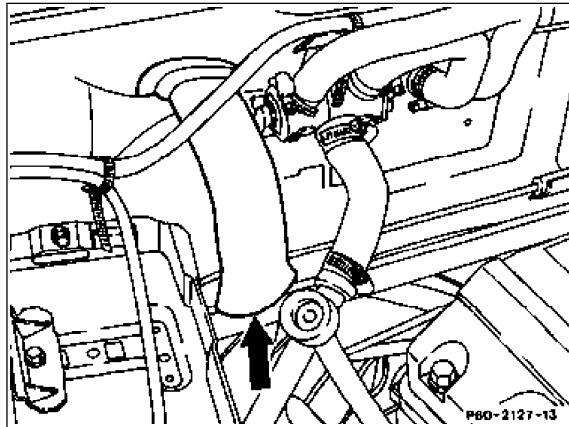

- Drain bores in cover on air intake

Model 126

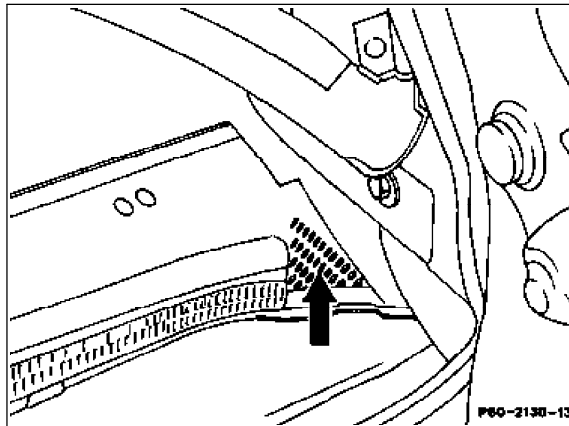

- Water box, outer

Model 126

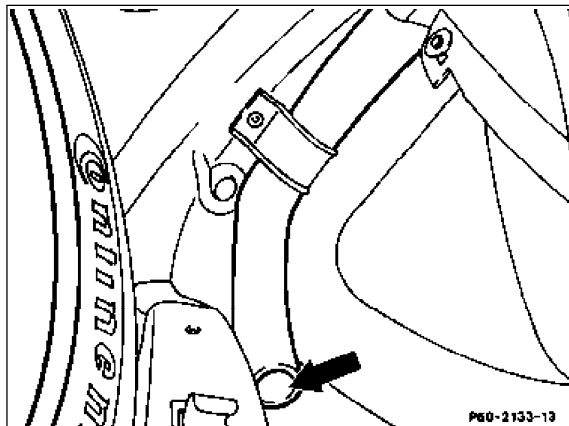

- Water box, center

Model 126

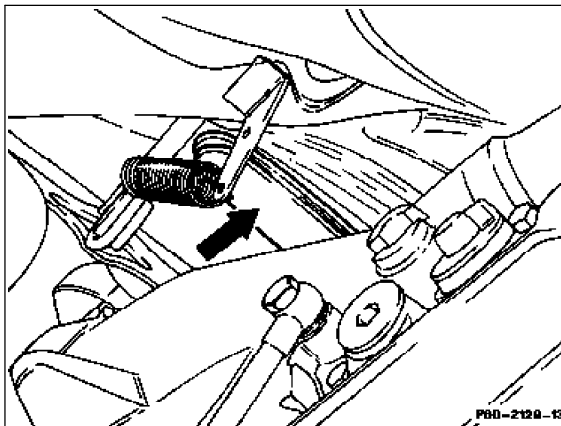

P80-2128-13

- Air conditioning

Models 124, 126, 129, 140

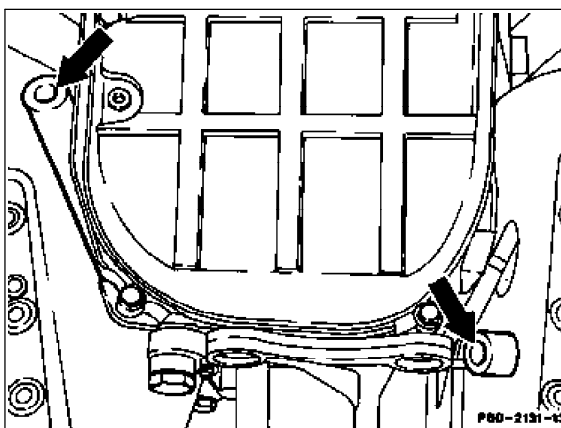

P80-2131-13

- Heating and air conditioning (in transmission tunnel)

Models 124, 126, 129, 140

Models 124, 126, 129, 140
Models 107, 123

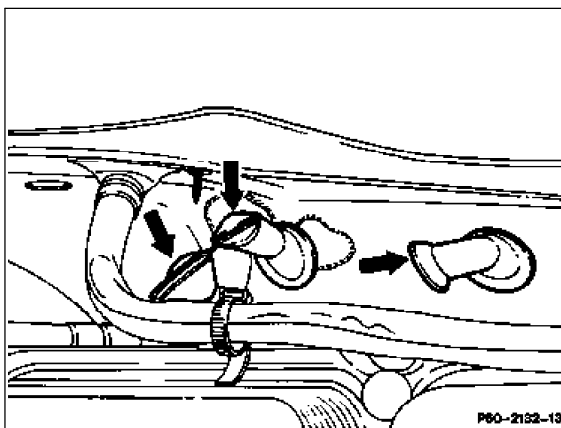

P80-2132-13

- Sliding roof front

All models

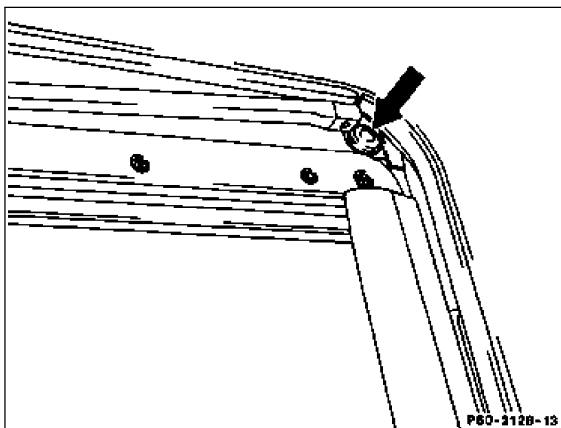

P80-2128-13

- Front wall pillar top

Models 124, 129, 140, 201

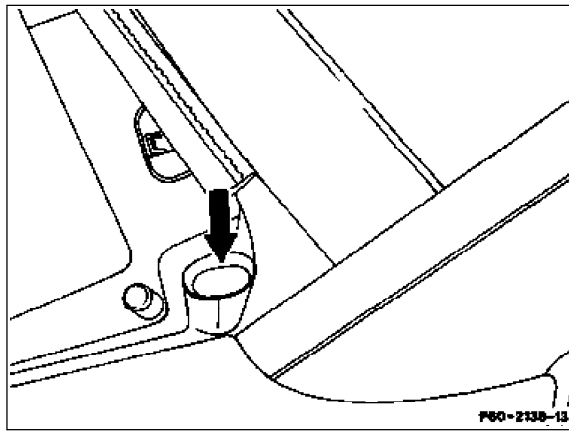

- Front wall pillar below (arrow top)
- Units compartment (arrow below)

Models 124, 201

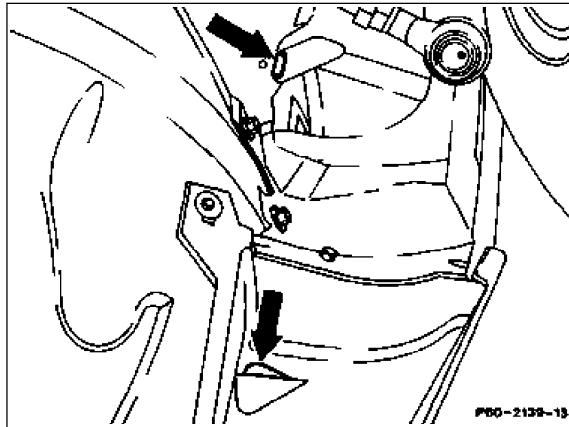

- Water box

Models 124, 201

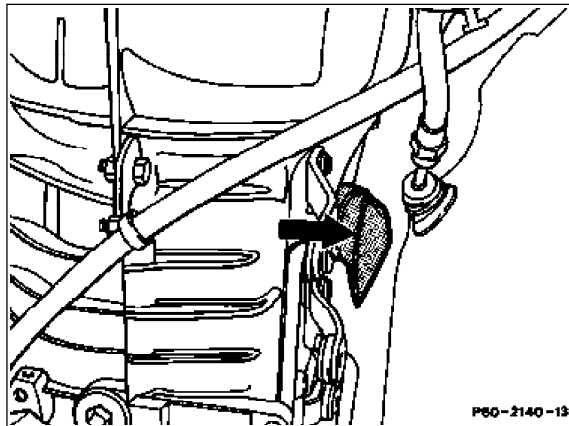

- Water box

Model 129

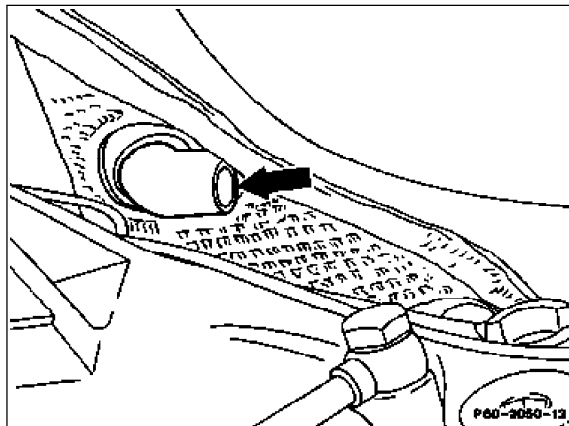

- Water box

Model 140

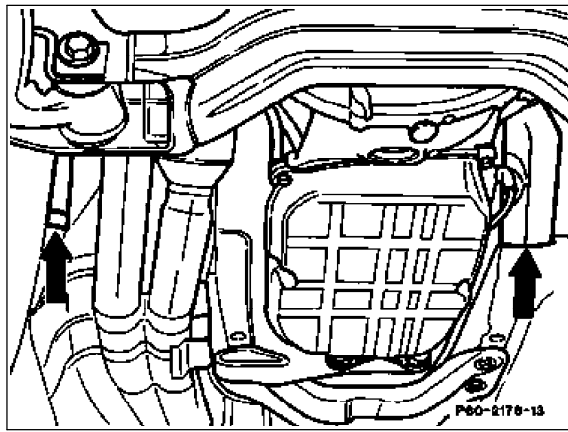

- Lower fill-in well

Model 140

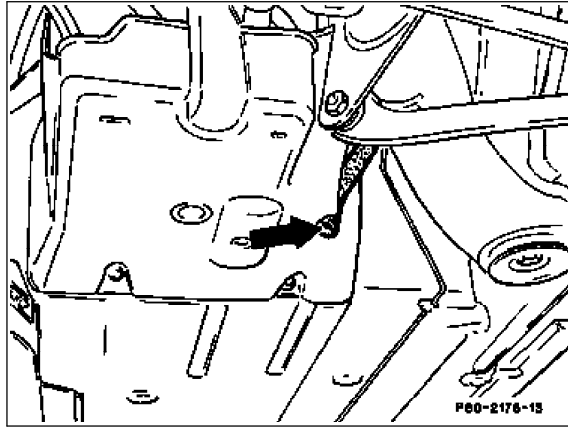

- Front wall pillar bottom

Models 129, 140

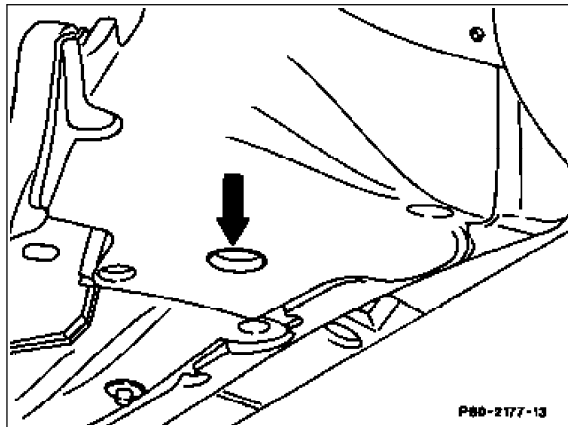

- Rear air conditioning system

Model 140

